

Article number: 3901150030500

Description: Worm gear with solid input shaft
VF 150FC-30-HS

Measures

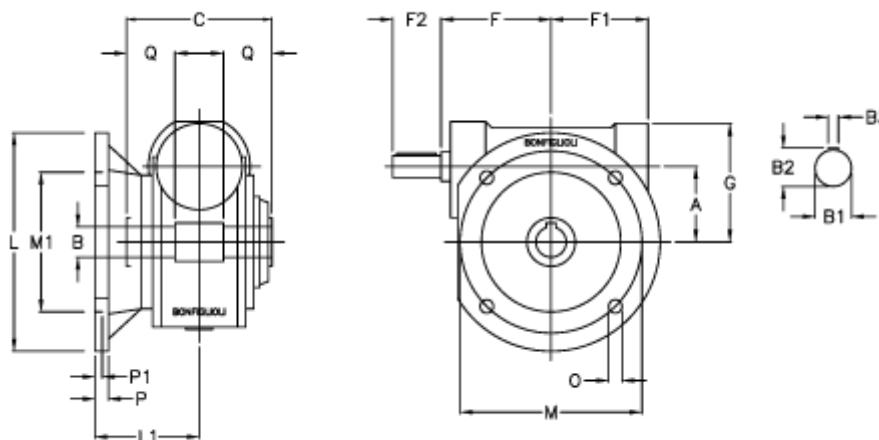

a	= 150.0	F1 = 179	P = 22
B	= 50	F2 = 65	P1 = 13
B1	= 35	g = 218	Q = 55.0
B2	= 38	L = 350	
B3	= 10	L1 = 145.5	
C	= 175	m = 290	
Description	= VF 150FC-xx-HS	M1 = 200	
F	= 185.0	O = 18	